

ROSCO

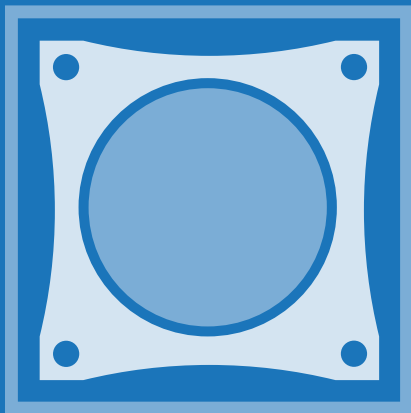

PICA CUBE™
DESIGNED BY THE BLACK TANK

USER'S MANUAL

Table of Contents

Your Pica Cube™

Product Description.....	5
What's In the Box.....	7
Pica Cube™ Interface.....	8
Pica Cube™ Revision Check.....	9

Pica Cube™ Series

Pica Cube™ 4C.....	10
Pica Cube™ WNC.....	11
Pica Cube™ UV.....	12

Pica Cube™ Modes

DMX Mode.....	13
Manual Mode.....	18
Color Wash Mode.....	20
Preset Mode.....	22
Serial Mode.....	24

Beam Angles

Diffuser.....	25
Changing Diffusers.....	26

Table of Contents

Mounting and Configuration

Safety Cables.....	27
--------------------	----

Make Your Own Cables

DMX & Power Cable Pinout Diagram.....	28
---------------------------------------	----

Pica Cube™ Support

FCC Warning.....	29
General Precautions.....	30
Warning Messages.....	31

Pica Cube™ Series

Rosco's innovative Pica Cube™ series of LED wash lights pack 1100 lumens of output into a compact and portable 2.5 inch cube, while only consuming 22-24 Watts of power! The sleek yet rugged, geometric design of the Pica Cube™ is perfectly at home in entertainment environments, museums, stores and lobbies, built into sets, truss and lighting rigs of all styles.

These luminaires offer the flexibility and versatility needed for any type of lighting challenge. The Pica Cube™ can be powered via a wall adapter or by using a Pica Portal™ (sold separately) which gives you power and data over CAT5e cable.

An intuitive control panel sets virtually every aspect of the lights including a master-slave configuration for fast lighting set-ups. With several modes you can control your light with no limitations.

Product Description

Weighing just under 1 pound, mounting these compact 2.5 inch cubes is limited only by the imagination of the installer. The one sided bolted yoke design allows units to be easily mounted on any surface for greater output and coverage.

Available in versions that offer full quad chip color mixing, tuneable color temperature white light and true UV LED blacklight, the Pica Cube™ luminaires are the smallest, most feature packed and affordable, professional grade LED lights on the market.

What's In the Box

Pica Cube™

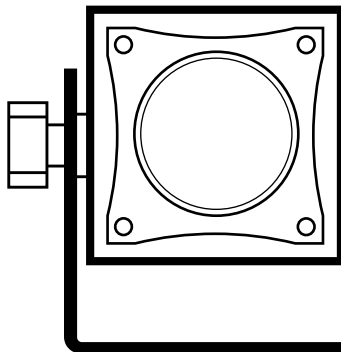

Diffuser Pack

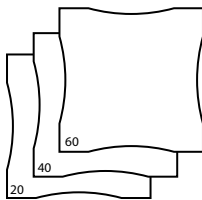

Pica Cube™ Interface

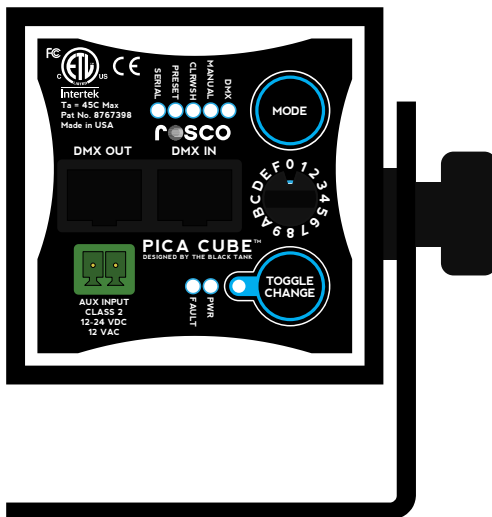

Pica Cube™ Revision Check

During your Pica Cube's™ boot sequence, there will be a lamp test which illuminates all indicators on the rear panel.

After the Lamp test, the green mode indicator LEDs will flash the firmware revision of your Pica Cube™ in Binary.

REVISION EXAMPLES

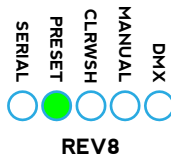
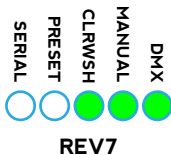
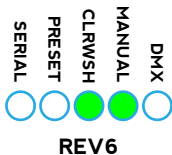
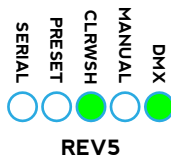
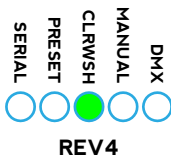
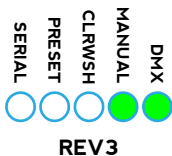

Pica Cube™ 4C

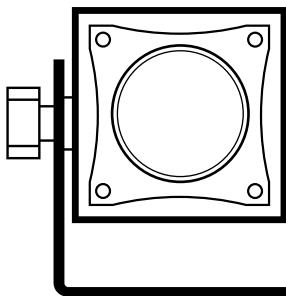

From walls to washes to uplighters, the Pica Cube™ 4C color mixing wash light offers a designer maximum creativity in a tiny package. Using best in class RGBW quad color, multi channel chip, a gorgeous palette of saturated, mid-tone and pale tint colors can be dialed in at the spin of a knob. And of course, a true white is always available as well, not the unflattering mixed amber compromise found in other lights. Smart programming in the

Pica Cube™ 4C includes a stand-alone color wash mode or allows multiple units to be easily slaved together, synchronized and offset using self-generated DMX for color chases and other dynamic lighting patterns without a console. Use it alone, configured in strips & arrays or built-in for virtually any application needing colored light - from stage, studios and location, bars and casinos, to stores, windows and lobbies.

NOTE: The luminaire should be positioned so that prolonged staring into the luminaire at a distance closer than 3.3m is not expected.

Pica Cube™ WNC

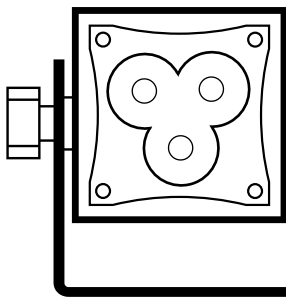

Size Matters. But quality of light matters more! The Pica Cube™ WNC embodies what every lighting professional needs - A bright, tuneable, beautiful white light. Using high quality Cree XML 4W emitters, the WNC outputs 1005 lumens and can adjust from 2700K to 6500K. A mix of warm, neutral and cool LEDs insure excellent rendering across all color temperatures making it perfect for use on TV, film sets, in retail lighting, museums, architecture, photography studios

or any white light application.

NOTE: The luminaire should be positioned so that prolonged staring into the luminaire at a distance closer than 3.3m is not expected.

Pica Cube™ UV

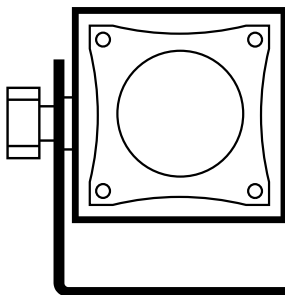

Ideally suited for theme parks, night clubs, casinos, museums and stage applications, Pica Cube™ UV is the smallest, most affordable high powered UV light available to lighting professionals. Drawing just 22-24 watts, it outperforms conventional long throw fixtures using two times the power, weighing 10 times more, and which need an expensive lamp change every 1000 hours! The fixture allows for full speed DMX dimming and standalone control.

DO NOT look directly into the ultra-violet LED (hereinafter referred to as “UV-LED”) during operation of the device. THE UV-LED radiates intense ultra-violet light (hereinafter referred to as “UV light”) and can be harmful to the eyes even during a brief period of exposure. *UV-LED means any UV-LED dice or packaged UV-LEDs which emit ultra-violet light whose peak wavelength is shorter than 400nm.

2. **ALWAYS** wear UV protective eyewear when handling the UV-LEDs.
3. UV light can cause skin damage, up to and including, skin cancer. ALWAYS wear protective clothing to prevent UV-LED exposure to skin.
4. **ALWAYS** instruct and warn all intended users of proper handling of the UV-LEDs and all potential hazards. **ALWAYS** provide proper instructions, labels and warnings with your product in accordance, at minimum, with the standards set forth by the International Electric Committee (IEC). **ALL** UV light should be used in your product in such a way as to ensure that no direct exposure to the UV light on the human.

DMX Mode

In DMX mode, the unit is controlled by the data it receives on the RJ45 connectors located on the rear panel. The RJ45 located at the center of the back panel (DMX In) also serves as a power input. The number of DMX channels required to control the fixture is dependent on the factory setting in use (for example - four color Cubes™ use four DMX Channels while one color Cubes™ use one).

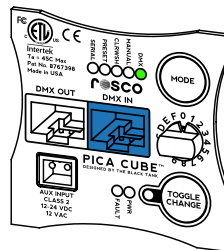

RDM (Remote Device Management):

Pica Cubes™, **REV4 and newer**, have RDM (Remote Device Management) functionality. RDM allows bidirectional control and communication over the DMX512 cable. See Below for RDM Command List:

- DISC_UNIQUE_BRANCE
- DISC_MUTE
- DISC_UN_MUTE
- STATUS_MESSAGES **G**
- STATUS_ID_DESCRIPTION **G**
- SUPPORTED_PARAMETERS **G**
- DEVICE_INFO **G**
- DEVICE_MODEL_DESCRIPTION **G**
- MANUFACTURER_LABEL **G**
- DEVICE_LABEL **G/S**
- SOFTWARE_VERSION_LABEL **G**
- DMX_PERSONALITY **G/S**
- DMX_PERSONALITY_DESCRIPTION **G**
- DMX_START_ADDRESS **G/S**
- SENSOR_DEFINITION **G**
- SENSOR_VALUE **G**
- OUTPUT_RESPONSE_TIME **G/S**
- OUTPUT_RESPONSE_TIME_DESCRIPTOR **G**
- MODULATION_FREQUENCY **G/S**
- MODULATION_FREQUENCY_DESCRIPTOR **G**
- DEVICE_HOURS **G**
- DEVICE_POWER_CYCLES **G**
- IDENTIFY_DEVICE **G/S**
- RESET_DEVICE **S**

G = GET S = SET

DMX Mode

There are four user settings that can be adjusted - DMX Address, 8 or 16 Bit Mode, Filament Fade Mode and PWM Frequency.

DMX Address:

To change the DMX address, while in DMX Mode, press the **TOGGLE** button. The Status LED will begin to blink slowly and at this time adjust the **KNOB** to set the first digit of your address. Once you have selected the first digit press the **TOGGLE** button to lock it in. The status LED will blink rapidly for a brief moment telling you that the first digit is locked and ready for the second digit. Repeat this step again for the second and third digits and press the **TOGGLE** button upon completion.

NOTE: It is important that you include leading zero's in the first and second digits if necessary. Also make sure you enter a valid DMX address (**001-512**) otherwise the fixture will default to your previous address.

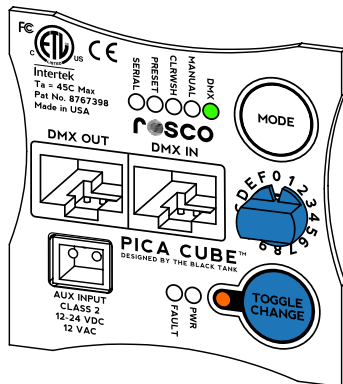

DMX Mode

8 bit or 16 bit DMX:

The fixture can run in either 8 bit or 16 bit DMX Mode. In 8 bit mode, the Pica Cube™ accepts one DMX channel for each color. In 16 bit mode, two channels are required for each color. To choose 8 or 16 bit, in DMX Mode press and hold **TOGGLE** until the status LED blinks rapidly. Then rotate the **KNOB** to desired bit setting (**8 ► TOGGLE = 8bit**) and (**1 ► TOGGLE ► 6 ► TOGGLE = 16bit**). The Status LED will blink rapidly notifying you the desired bit setting has been saved.

Filament Fade:

An incandescent lamp has a slight delay, or lag with changing intensities, whereas an LED responds instantly. The difference is most noticeable during a theatrical black out. The Pica CUBE™ can emulate an incandescent lamp by selecting one of the Filament Fade settings.

To change the Filament Fade Setting switch the mode to **SERIAL** mode. Once in Serial Mode you will hold the **TOGGLE** button until the status LED blinks rapidly. Then rotate the **KNOB** to desired Filament Fade setting as follows (0 = off, 1 = low, 2 = medium, 3 = high). Press **MODE** to save and exit. Then change back to DMX Mode.

DMX Mode

PWM Frequency:

Pica Cubes™, **REV4 or Newer**, can be set to PWM at 4kHz or 16 kHz using RDM or the user interface.

You can determine the PWM setting by watching the green **MODE** LEDs during the boot sequence. If the green mode LEDs abruptly turn off after the lamp test, your Pica Cube™ is set to 4kHz mode. If the green mode LEDs swoop off from left to right, your Pica Cube™ is set to 16kHz mode.

To change your Pica Cubes™ PWM Frequency, ensure you are in **DMX** mode. Then hold **TOGGLE** button until the status LED begins blinking rapidly. Then rotate the **KNOB** to enter desired PWM Frequency:

16 kHz Frequency

F ► TOGGLE ► 1 ► TOGGLE ► 6 ► TOGGLE

4 kHz Frequency

F ► TOGGLE ► 0 ► TOGGLE ► 4 ► TOGGLE

Once you have selected your desired frequency press **MODE** to save and exit.

DMX Channel Layout:

8 BIT MODE:

4C

- 1 - Red
- 2 - Green
- 3 - Blue
- 4 - White

WNC

- 1 - Warm
- 2 - Neutral
- 3 - Cool

UV/3W/3N

- 1 - All LEDs

16 BIT MODE:

4C

- | | |
|------------------|------------------|
| 1 - Red Coarse | 5 - Blue Coarse |
| 2 - Red Fine | 6 - Blue Fine |
| 3 - Green Coarse | 7 - White Coarse |
| 4 - Green Fine | 8 - White Fine |

WNC

- | | |
|--------------------|------------------|
| 1 - Warm Coarse | 4 - Neutral Fine |
| 2 - Warm Fine | 5 - Cool Coarse |
| 3 - Neutral Coarse | 6 - Cool Fine |

UV/3W/3N

- 1 - All LEDs Course
- 2 - All LEDs Fine

Manual Mode

In Manual Mode, the Pica Cube™ can be controlled directly from its rear panel without the need of a DMX console or a DMX control device. Standalone control capabilities vary according to the factory setting in use (Four Color, Three Color, or One Color). The Pica Cube™ has a self recognizing interface, meaning you don't have to configure it at the possibility you changed LED boards.

(All standalone, DMX address and configuration settings are non-volatile, meaning they will not change if power is lost or switched off and restored. When set to manual mode, the Pica Cube™ operates as a DMX Master and is sending DMX512 data.)

NOTE: Do not connect any Pica Cube™ in Manual Mode to any other DMX sending device as contention on the DMX512 input will result.

Manual Mode

Manual Mode allows you to set the color of your fixture by adjusting the intensity of the LEDs using the rear panel. The current value of each setting is created by adjusting the **KNOB** and **TOGGLE** button.

There are two types of adjustments you can make in Manual Mode, Coarse and Fine.

To set the coarse adjustment press **TOGGLE** until desired color flashes and the status LED is blinking slowly. Rotate the **KNOB** until desired setting is achieved (0 = off, 8 = medium, F = maximum). Press **MODE** to save and exit. You can also press **TOGGLE** to adjust the next color or hold **TOGGLE** to adjust the fine color setting.

To set the fine adjustment hold **TOGGLE** after coarse adjustment is made. The status LED will begin to blink rapidly. Rotate the **KNOB** to the desired fine setting. Press **MODE** to save and exit or press **TOGGLE** to set the next color coarse setting.

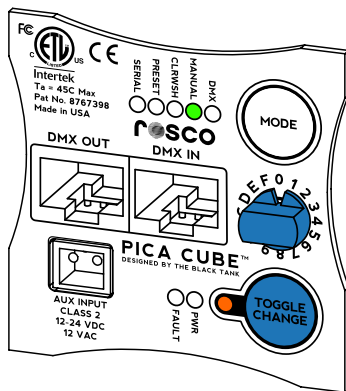

Color Wash Mode

Color wash is only available in Pica Cube™ 4C. In Color Wash mode, the Pica Cube™ automatically cycles through its entire saturated color spectrum by modulating the intensity of the red, green, and blue LEDs.

There are two user settings that can be adjusted in Color Wash Mode - Wash Timer and Wash Offset.

Wash Timer:

The wash timer determines how long it takes for the Pica Cube™ to complete an entire color cycle, and by extension, the rate at which the colors change. Choose a short time for a rapid wash or a longer time for a slower wash. To change the Wash Timer press **TOGGLE**. The status LED will begin to blink slowly. Rotate the **KNOB** to desired Color Wash speed (0 = 15s, 8 = 16.5min, F = 60min). Once your speed is achieved, press **MODE** to save and exit.

Wash Offset:

When set to Color Wash Mode, the Pica Cube™ is operating as a DMX master and is sending DMX512 data, allowing it to control unique color washes on up to fourteen additional fixtures in a chain (set to DMX mode).

Color Wash Mode

Use the Wash Offset function to control the interaction between multiple Pica Cubes™ in a Color Wash chain. The Wash Offset determines the length of delay between each light, or how long it takes to “pass” a color from one light to the next. Set the Wash Offset to “0” and the lights will color wash in unison, displaying the same color at the same time. Create a multi-fixture Chasing Rainbow effect, where colors pass from light to light, by increasing the Wash Offset. The larger the offset time, the longer it takes for a color to pass to the next light.

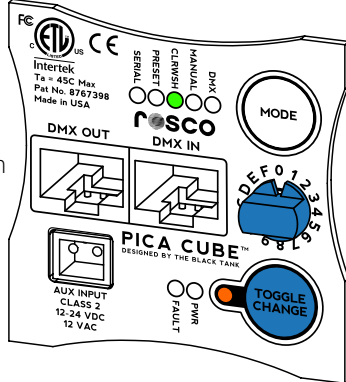

To change the Wash Offset, hold the **TOGGLE** button until the status LED blinks rapidly. Rotate the **KNOB** to desired offset (0 = no offset, 8 = medium offset, F = large offset). Once desired Color Wash offset is achieved, press **MODE** to save and exit.

Preset Mode

In Preset Mode, the Pica Cube™ can be controlled directly from its rear panel without the need of a DMX console or a DMX control device. This mode is only available in the 4C and WNC Configurations. Preset mode allows you to tune your fixture to various color temperatures ranging from 2700K to 6500K, or select from a set of saturated colors.

When set to preset mode, the Pica Cube™ operates as a DMX Master and is sending DMX512 data. (All Standalone settings, DMX setting and configuration settings are non-volatile, meaning they will not change if power is lost or switched off and restored.)

To change the Preset Intensity, press the **TOGGLE** button until the status LED blinks slowly. Rotate the **KNOB** to desired intensity (0 = off, 8 = medium intensity, F = high intensity). Once desired color achieved, press **MODE** to save and exit. To change the color temperature or saturated color hold the **TOGGLE** button until the status LED blinks rapidly. Rotate the **KNOB** until the desired color is selected (Use next page to see color settings). Press **MODE** to save and exit.

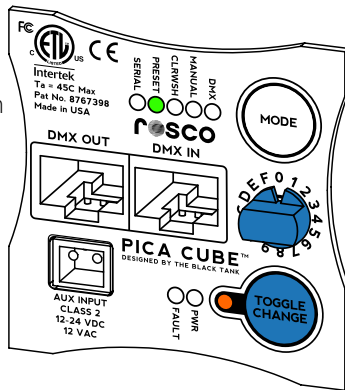

Preset Mode

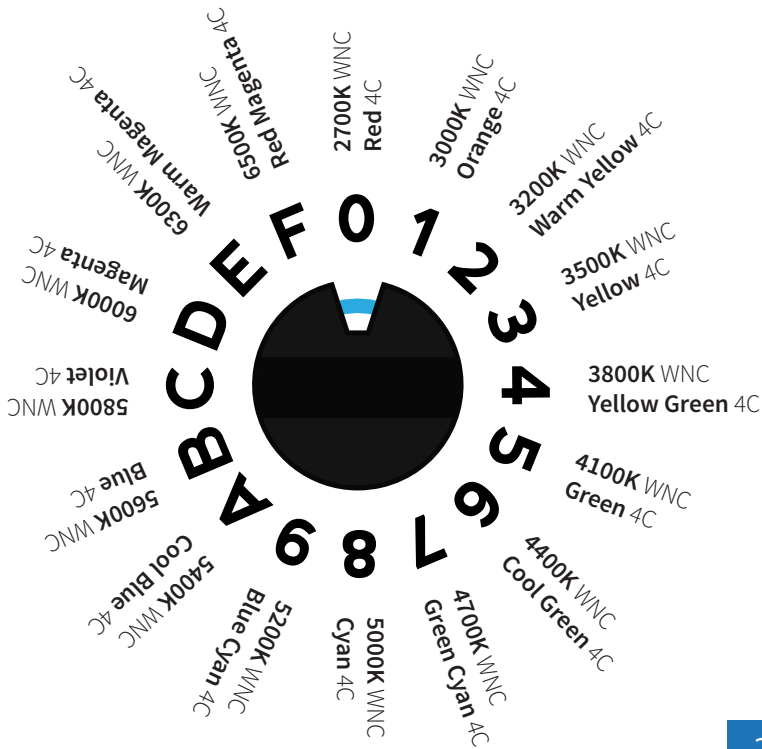

Serial Mode

In Serial mode, the unit is controlled by the serial data it receives on the RJ45 connectors located on the rear panel. The serial address required to control the fixture is dependent on the factory setting in use (for example - four color Pica Cubes™ use four DMX Channels while one color Pica Cubes™ use one).

Serial Address

To change the Serial address while in Serial Mode press the **TOGGLE** button. The Status LED will begin to blink slowly and at this time adjust the **KNOB** to set the first digit of your address. Once you have selected the first digit press the **TOGGLE** button to lock it in. The status LED will blink rapidly for a brief moment telling you that the first digit is locked and ready for the second digit. Repeat this step again for the second and third digits and press the **TOGGLE** button upon completion.

NOTE: It is important that you include leading zero's in the first and second digits if necessary. Also make sure you enter a valid Serial address (**001-512**) otherwise the fixture will default to your previous address.

Beam Angles

The beam angle can be easily adjusted using a holographic diffusing film. Using a Pica Cube™ without a diffusing film will create a narrow beam angle.

WARNING: Disconnect the power cable before removing thumbscrews.

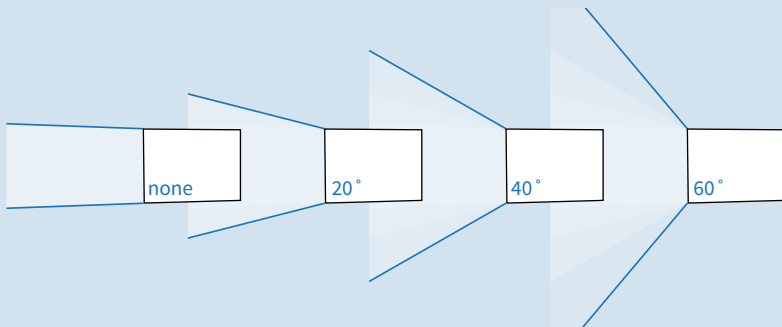

Beam Angles

To change the diffusing film, unscrew the thumbscrews from the front lens and remove the acrylic lens. Replace the existing film with the diffuser of your choice. Place the acrylic lens on top and secure it with four thumbscrews.

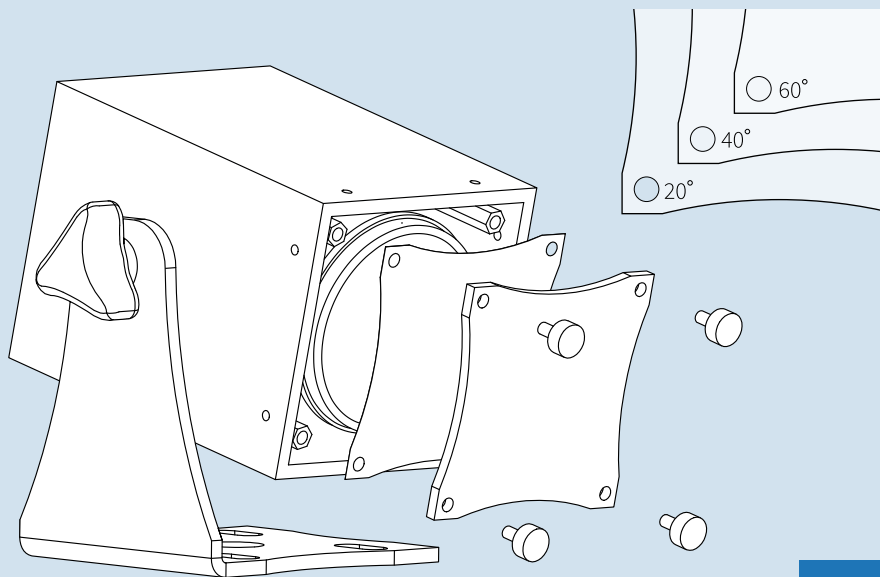

DMX & Power CAT5 Pinout Diagram

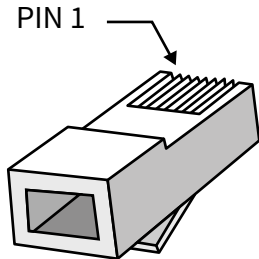

Pinout Chart

Channel	Color Pair	RJ-45 Pins
Data+	White/Orange	1
Data-	Orange	2
Power+	White/Green	3
Power-	Green	6
Power+	White/Blue	5
Power-	Blue	4
Data Com	White/Brown	7
Serial In	Brown	8

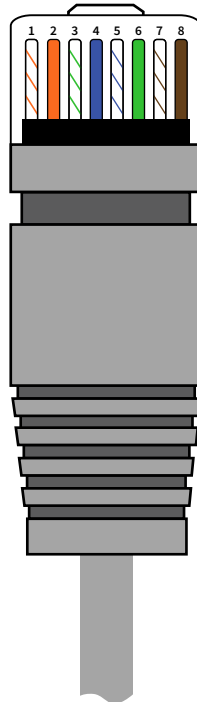

FCC Warning

This equipment has been tested and found to comply with the regulations for a Class A digital device, pursuant to Part 15 of the FCC Rules. These limits are designed to provide reasonable protection against harmful interference when the equipment is operated in a commercial environment. This equipment generates, uses, and can radiate radio frequency energy and, if not installed and used in accordance with this user's guide, may cause harmful interference to radio communications. Operation of this equipment in a residential area is likely to cause harmful interference, in which case the user will be required to correct the interference at his own expense.

General Precautions

1. The use of a safety cable is required when rigging the fixture.
2. Before use, make sure all screws and safety points are secured.
3. Make sure the light is unplugged before performing any service to the unit.
4. **ALWAYS** keep this product out of reach of children and untrained persons.
5. **ALWAYS** adhere to safety instructions and warnings, including any and all instructions set forth in the Product Specifications.
6. To allow for proper cooling, airflow must not be restricted through the front and rear of the fixture - do not block off the front or rear panel.
7. For Dry locations/Indoor use only.

Warning Messages

The Pica Cube™ has warning messages built in that will instruct you when an action needs to be taken.

On startup, if a DMX signal is not present on the DMX connectors, and the fixture is set to DMX mode, all of the LEDs will glow dimly. This feature can be used for troubleshooting your DMX control lines. Once DMX is detected the fixture will instantaneously respond to the command it is given.

The Pica Cube™ is equipped with an internal temperature sensor. If an overheat condition is experienced the Red **(4C)**, Warm **(WNC)** or **UV** LED will glow dimly and the fault LED on the back of the fixture will turn on. If this occurs unplug the power connector from the unit and wait three seconds. Plug the fixture in again. If the same condition occurs again contact the manufacturer.

The Pica Cube™ can also detect a fan speed fault. If this occurs the Blue **(4C)**, Cool **(WNC)** or **UV** LED will glow dimly and the fault LED on the back of the fixture will turn on. If this occurs unplug the power connector from the unit and wait three seconds. Plug the fixture in again. If the same condition occurs again contact the manufacturer.

ROSCO

PICA CUBE™
DESIGNED BY THE BLACK TANK